

OCCUPATIONAL DISEASES

-Hidden deaths spread over time-

& Work(site) Accidents



*Phase 1 lecture, 2020 - 2021
academic year, spring semester
8th June 2021, Ankara - TURKIYE*

Ahmet SALTİK, MD

Professor of Pubic Health

MSc, in Health Law

BSc, in Public Administration & Political Sciences



Occupational Health

is the promotion and maintenance of the highest degree of physical, mental and social well-being of workers in all occupations by preventing departures from **health**, controlling risks and the adaptation of work to people, and people to their jobs. (ILO / WHO 1950)

Please never
forget asking:

**«What is your
occupation?»**

*Labor is
the supreme
value.*

**Respect
to labor**

*is the chief
condition of
being human.*



Main headings - 1

- 1. What is your job?**
- 2. Definitions & objectives**
- 3. Importance of Occup. Dis.**
- 4. Occup. Disease in Turkiye**
- 5. Related legislation, regulat.**
- 6. Mandatory notification of Occup. Dis.& Work Accid.s**



Main headings - 2

- 7. Exposure & Liability periods**
- 8. MAC value (*Maximum Allowable Concentration*)**
- 9. *Treshhold Limit Value - TLV***
- 10. Prevention from Occup. Dis. & Work Accidents**
- 11. Dust, Noise, Lead, Benzen etc. problems..**
- 12. The ILO and International Role**
- 13. Conclusion & Recommendations..**

**“I am amazed and hesitant.
I wonder if I put the smelly
things in workplaces or invite
them to see these pits in the
nose of these magnificent
and stylish doctors sitting in
the offices.. ”**

**“Medicine will run
to the aid of employees
with all its means.”**

***Dr. Bernardino RAMAZZINI
Founder of Occup. Medicine
Italy, 1633 - 1714***



Milano, Occup. Dis. Hospital, 1722

Fig. 1 Bernardino Ramazzini (1633–1714).



Fig. 1 Bernardino Ramazzini (1633–1714).

Father of Occupational Medicine

Each chapter of the *De Morbis Artificum Diatriba* contains a description of the disease associated with a particular work activity followed by a literature analysis, workplace description, questions for workers, disease description, remedies, and advice. The clinical picture was directly observed by **Ramazzini**, who questioned workers about their complaints.

- *He regularly asked his patients about the kind of work they did and suggested that all physicians do the same.*

Ramazzini realized that not all workers' *diseases were attributable to the working environment* (chemical or physical agents). He observed that a variety of common workers' diseases appeared to be caused by prolonged, violent, and irregular motions and prolonged postures. Such cumulative trauma and repetitive motion injuries have recently been called the occupational epidemic of the 1990s. Ramazzini studied the relationship between certain disorders and postural attitudes, repetition of movements, and weight lifting and anticipated some preventive measures.

DE
MORBIS
ARTIFICUM
DIATRIBA

Mutinæ olim edita; nunc accedit Supplementum
eiusdem argumenti, ac Dissertatio de Sacrarum
Virginum Valetudine tuenda.

AUCTORE
BERNARDINO RAMAZZINI

In Patavino Gymnasio Præticæ Medicinæ
Professore Primario.



VENETIIS,
MDCCXLIII.

Apud JOSEPHUM CORONA,
In Via Mercatoria, sub Signo Præmii.
SUPERIORUM PERMISSU.

History-Ramazani-18th Century

- Father of OCCUPATIONAL Medicine
- Publish first systematic account on occupational Diseases-De Morbis Artificum/Disease and occupation
- Emphasize Obtaining Occupational History
- Introduce the practice of Doctors visit at workplace

Occupational Disease

- *Occupational diseases*

are diseases caused by work or work environment

- *Work-related diseases*

are diseases initiated, hampered or easy to get by work

- The ILO Employment Injury Benefits Recommendation, defines occupational diseases as following terms:

"Each Member should, under prescribed conditions, regard diseases known to arise out of the exposure to substances and dangerous conditions in processes, trades or occupations as occupational diseases

Occupational Health and Safety Act (2012)

«*Occupational disease*

is the condition of temporary or permanent illness, physical or mental disability that the insured worker is working on or caused due to the nature of the work, or for a recurring reason or due to the conditions of execution.»

(Act no 6331, art. 14)



**SUSTAINABLE
DEVELOPMENT GOALS**

2030

DECENT WORK AND THE 2030 AGENDA

Global Estimates

Global workforce E

3+ billion

Expected occupational disease

.... million

Work related fatalities

2.341 million

Occupational accidents

300+ million

Work-related diseases

160 million

Global income

30 000 B \$

(in 2020; ~85 Tr \$)

Lost GDP in accidents /diseases

4-6,5 %

Migrants

250+ million

Illiterate (7+ age)

1000 million

People in poverty

1000+ million

Child workers

~200 million

(J. Takala, ILO 2005
Updated figures..)



GLOBAL SAFETY STATISTICS

WORK-RELATED ACCIDENTS AND DISEASES RESULT IN 2.3 MILLION FATALITIES



AROUND THE WORLD EVERY YEAR

THIS EQUATES TO OVER 6000 DEATHS



EVERY SINGLE DAY

HAZARDOUS SUBSTANCES ALONE ARE ESTIMATED TO CAUSE 651,279 DEATHS



A YEAR

WORLDWIDE, THERE ARE 340 MILLION OCCUPATIONAL ACCIDENTS AND 160 MILLION VICTIMS OF WORK-RELATED ILLNESSES ANNUALLY



ILO UPDATES INDICATE AN INCREASE OF ACCIDENTS AND ILL HEALTH

Source: ILO International Labour Organization

www.iospa.com



WORKPLACE STRESS

A COLLECTIVE CHALLENGE

WORLD DAY FOR SAFETY AND HEALTH AT WORK
28 APRIL 2016

SafeDay

<https://youtu.be/kbSf4xeXwrE>

SafeWork: Strategy

- Integrating new aspects into occupational safety and health such as drugs and alcohol, stress and HIV-AIDS
- Strengthening knowledge, advocacy and capacity building
- Developing a global technical cooperation programme
- Fostering institutional collaboration, networking and partnerships



ILO: The ILO SafeWork Programme

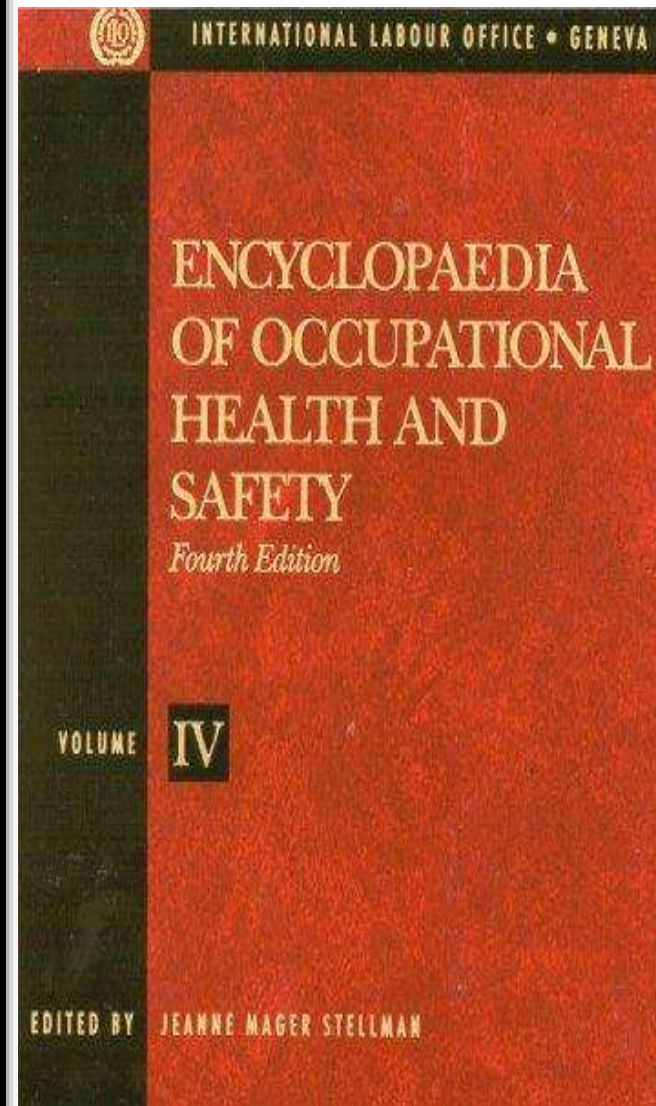

ABOUT THE ILO



- The tripartite U.N. agency (Geneva), since 1919 the ILO brings together governments, employers and workers representatives of 186 member States, to set labour standards, develop policies and devise programmes promoting decent work for all women and men.

The ILO has designed guidelines as a practical tool for assisting organizations and competent institutions as a means of achieving continual improvement in occupational safety and health (OSH) performance.

The guidelines have been developed according to internationally agreed principles defined by the ILO's tripartite constituents.





ev-**15** seconds
every a worker dies from a work-related accident or disease.

Every year, **2.3 million** people die from occupational accidents or work-related disease. **That's almost the entire population of Chicago.**



 ilo.org/infographics

Global burden of occupational health illnesses-1

- Let's share with you some facts from the ***ILO's report on the global burden of occupational health illnesses***:
- Of the world's 2.7 billion workers about **2 million deaths** are attributable to ***occupational diseases and injuries***
- About 4% of the GDP is lost due to occupational diseases and injuries.
- ***Health, Safety and Environment*** are enablers for economic development.
- All the three aspects of business are measured by their negative impact on people, assets and environment.

<https://www.ncbi.nlm.nih.gov/pmc/articles/PMC2796774/>
24.02.19



Do not use these silicon ear pieces in order to block your hearing not to hear OSH problems!

Global burden of occupational health illnesses-2

- The damage is
 - *acute in the area of safety,*
 - *chronic in the area of occupational health and*
 - *persistent in the case of environment.*
- While the impact of safety is felt immediately, the effects of OH related diseases are felt over generations. A prime example in India is the **Bhopal gas tragedy** 1984, India causing thousands of sudden deaths in 1 night!



<https://www.ncbi.nlm.nih.gov/pmc/articles/PMC2796774/>
24.02.19

Robert Beaglehole and Ruth Bonita

Public Health at the Crossroads

Achievements and Prospects

Second Edition

**Health should
be at the heart
of the global
development
agenda..**

***Out of sight ..
Girls in mining!***



**Illegal child labor at mining
& child mother..
Double burden for the poor..**

Global Estimates of Occupational Accidents and Work-related Illnesses 2014



Made for the ILO Report at XX World Congress, Frankfurt





**~1 million
child labor**
TSI - 2020



Illegal child labor, child prostitute! Just a shame!

28th April 2018, ILO: Particularly for Young workers call the World to improve their risky working conditions.

The United Nations defines “youth” as anyone between the ages of 15 and 24. By this definition, there are 541 million young workers in the world today, accounting for over 15% of the global labour force.

28th April 2018

World Day for Safety and Health at Work

- Invest in young workers’ safety and health
- In a statement to mark ‘**World Day for Safety and Health at Work**’, ILO Director General Guy Ryder calls for action to
 - **make workplaces safe for young workers.**

28 April: Commemoration of Work Murders and Remembrance Day Announced! Fight for the Living, commerate the deaths..!



**WORLD DAY FOR SAFETY
AND HEALTH AT WORK**

28 April 2018

#GenerationSafeandHealthy



6.06.2021



**Safety and health at work:
Why are youth at risk?**

www.ahmetsaltik.net

21

MANUFACTURING at DARK & MER INSTEAD OF MAN!

Changing Precision Technology



<https://www.elektrikde.com/gelecegin-uretim-modeli-inarsiz-uretim-ve-karanlik-fabrikalar/> 25.12.19

Legal definition of Occup. Dis.

- ★ *Social Insurance and General Health Insurance Law No. 5510, 2008*
Art. 14 : Occupational disease,
Temporary or permanent illness, physical or mental disability that the «insured» suffers due to a recurring reason due to the nature of the job he / she is working or doing, or due to the conditions of the job.
- ★ **Occupational Health and Safety Law No. 6331**
(30.6.12) Occupational disease; It is a disease that occurs as a result of exposure (exposure) to occupational risks. (Art. 3 / I)

Warnings by ILO



- ***Out of sight – girls in mining!***
- *A new ILO study shows that not only are children still being forced to work in mines, but many of them are **girls**. It is child labour in its worst form:*
- *Young girls risk permanent injury from carrying heavy loads of rock and contamination from nerve-damaging mercury. Without a chance to go to school, **they are locked into a life of poverty.***

www.ilo.org/global/, 18.09.07

ILO

OCCUPATIONAL SAFETY AND HEALTH STANDARDS (ii)

- The Occupational Safety and Health Convention 1981 (No 155)
- The Occupational Health Services Convention 1985 (No 161)
- The Promotional Framework for Occupational Safety and Health Convention 2006 (No 187)

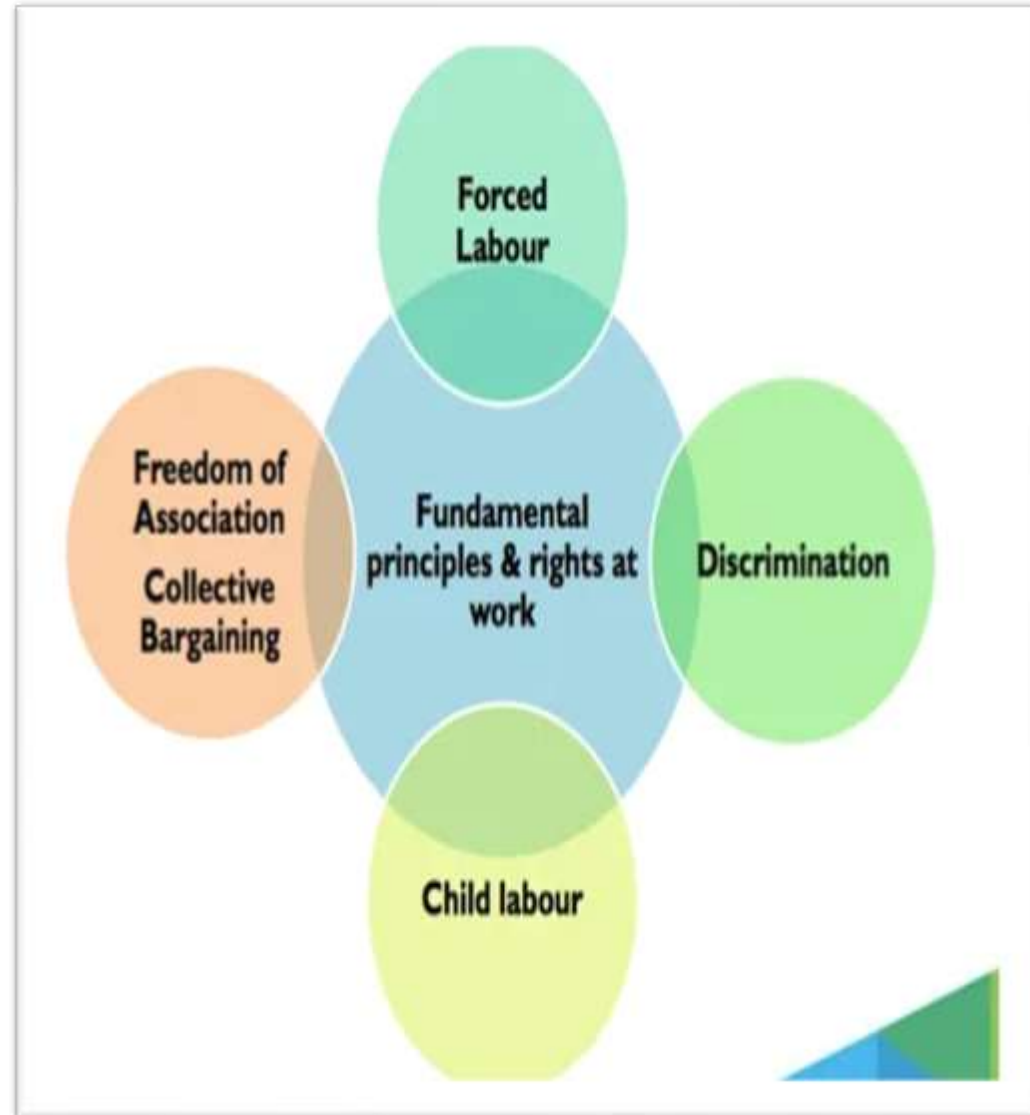



«Truck : Carrying cargo with a maximum permissible laden weight of more than 3 500 kg.»

(HIGHWAY TRAFFIC LAW, art. 3)

It is a motor vehicle manufactured for carrying load but not human beings, poor workers..

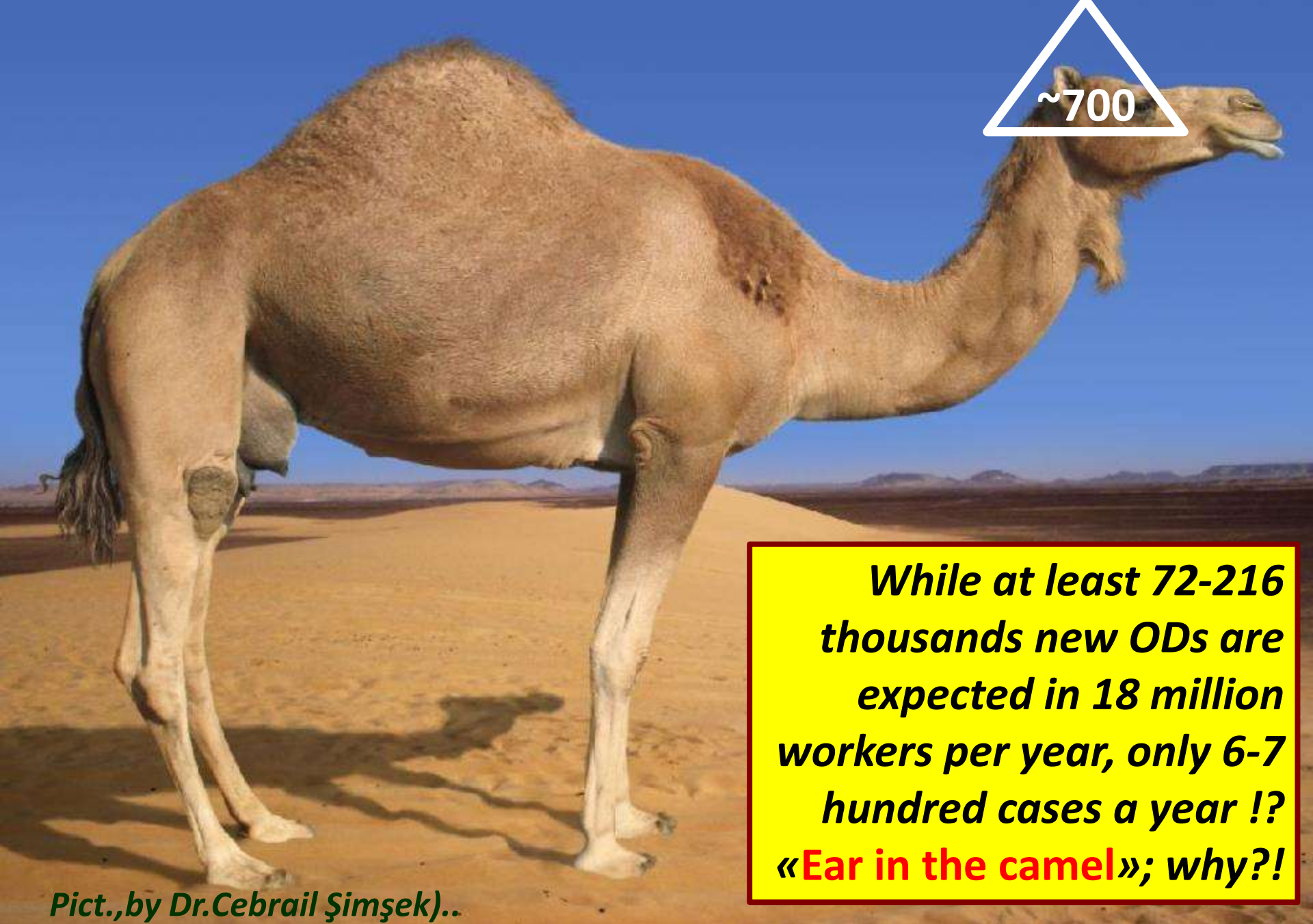

~700

While at least 72-216 thousands new ODs are expected in 18 million workers per year, only 6-7 hundred cases a year !? «Ear in the camel»; why?!

Pict.,by Dr.Cebrail Şimşek)..

World Day for **Safety and Health** at Work : *History of 28 April*

In 2003, the ILO began to observe **World Day** stressing the *prevention of illness and accidents at work*, capitalizing on its traditional strengths of **tripartism** and **social dialogue**. 28 April is also a day the World's trade union movement has long associated with commemorating victims of **occupational accidents and disease**.

- The Occupational Safety and Health Convention 1981 (No 155)
- The Occupational Health Services Convention 1985 (No 161)
- The Promotional Framework for Occupational Safety and Health Convention 2006 (No 187)

Warns by UNICEF

- Web sitesinde yer bulan temel tematik alanlar :
- *Under-five deaths fall below 10 million annually*
- *Youths vulnerable to military re-recruitment*
- *Stop Child Abuse campaign asks for dramatic change*
- *Go to school: Suku's story*
- ***A life lived in 'exit mode'***
- – ***floods continue to bring destruction..***
- ***Child labor is still a serious challenging issue..***





Workers - especially those working in the industry - work in workplaces filled with a number of special risk factors. A wide variety of risk factors that workplaces have negatively affect the health of employees. Identification of these factors is the 1st condition to take protective measures. These risk factors can be categorized in 5 main clusters:

- Physical**
- Chemical**
- Biologic**
- Psycho-social**
- Ergonomic**
risk factors..

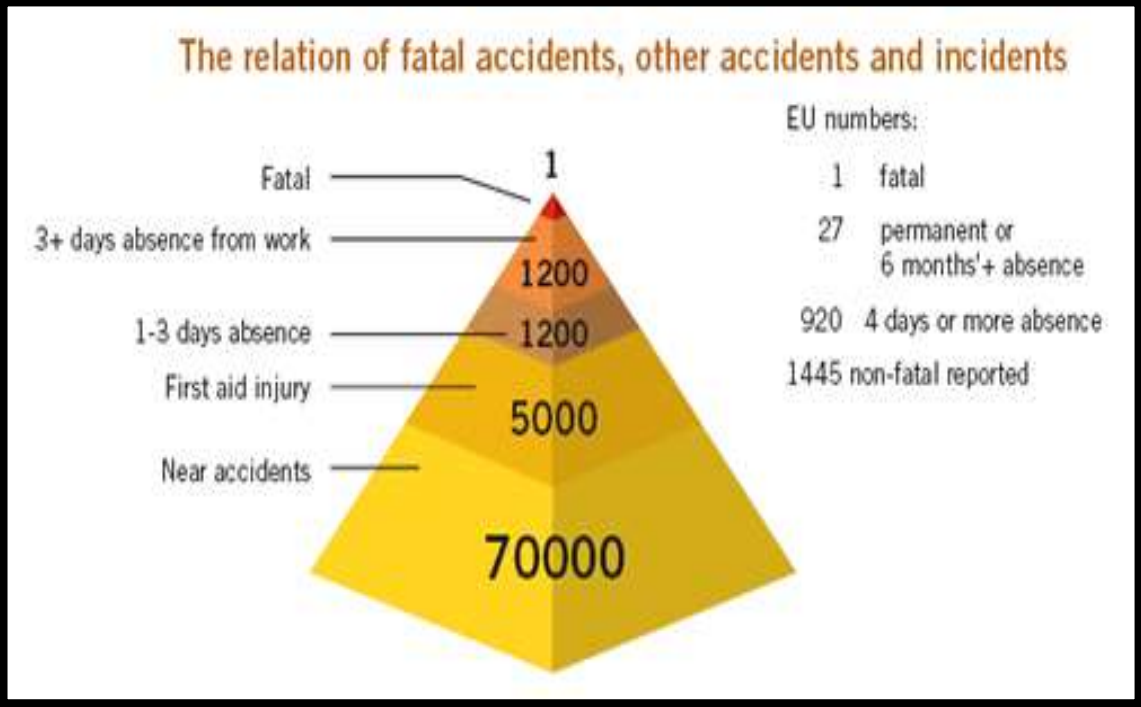

Pneumoconiosis

Pneumo : Lung

Conis : Dust

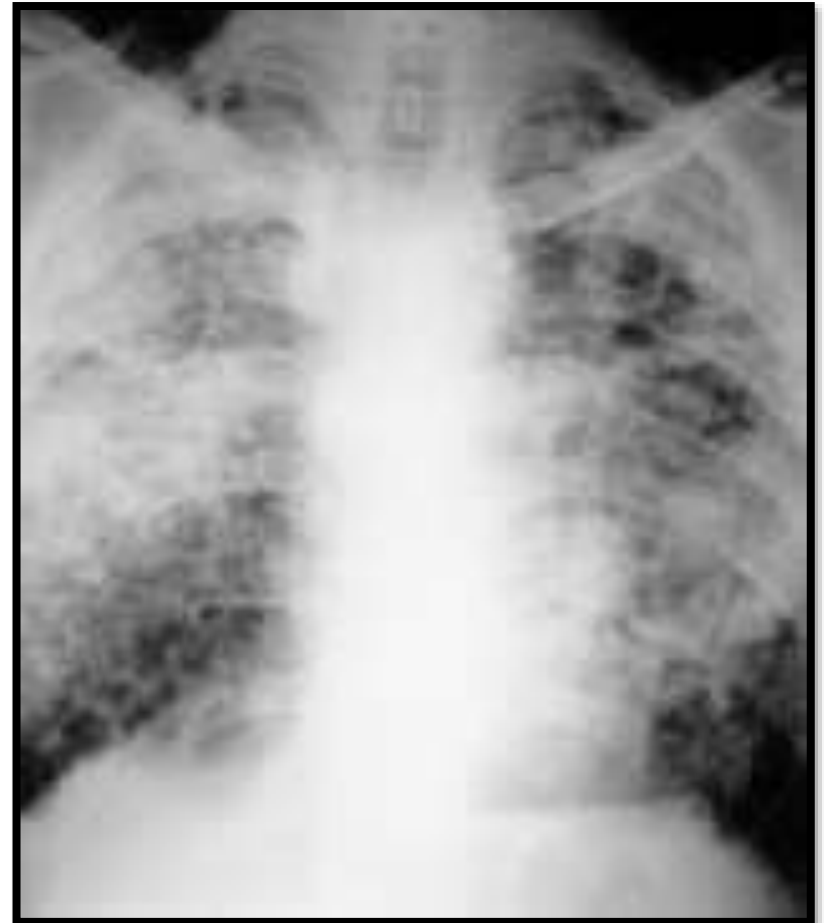
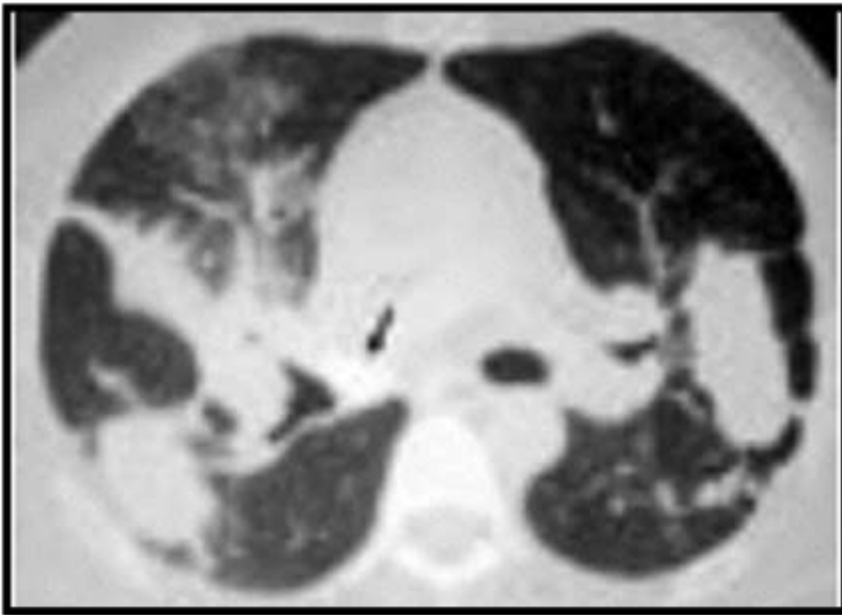

Silicosis & Pneumoconiosis patients



***Rheumatoid arthritis & Pneumoconiosis
due to chronic inhalation of coal dusts***



3 main intake routes of harmful agents..

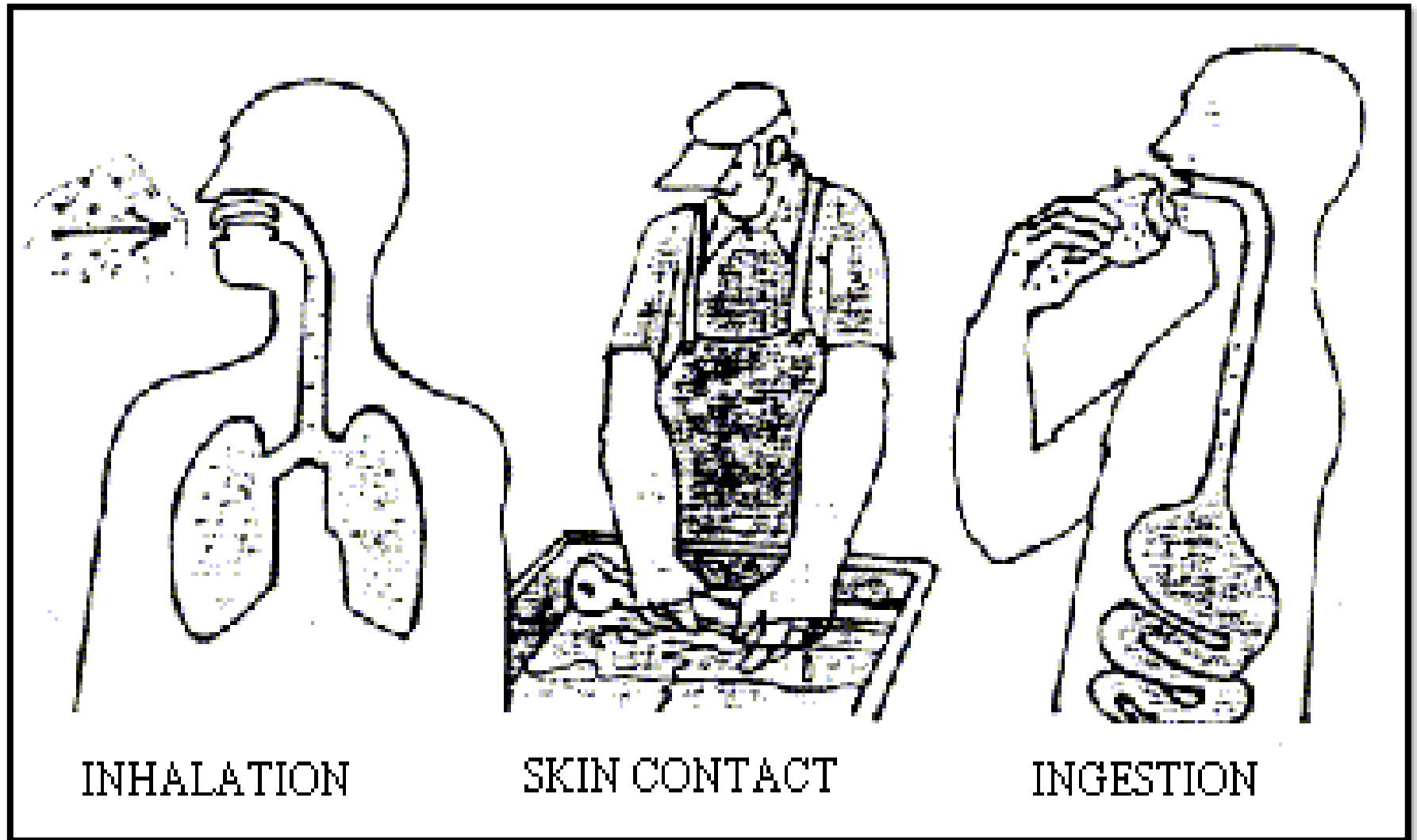



A



B

LOCAL DUST CONTROL AT CUTTING AND POLISHING:
TECHNICAL SOLUTIONS A AND B. WHICH ONE TO CHOOSE?

Crude dust sampler..



(Ahmet Saltik's personal archive)

***Masks should be specific
to the gas – dust - agent encountered..***





Dusts accumulated in the cotton fabric factory .. and BYSSINOSIS

6.06.2021

www.ahmetsaltik.net

39

Respiratory Function Tests : NORMAL SPIROGRAM

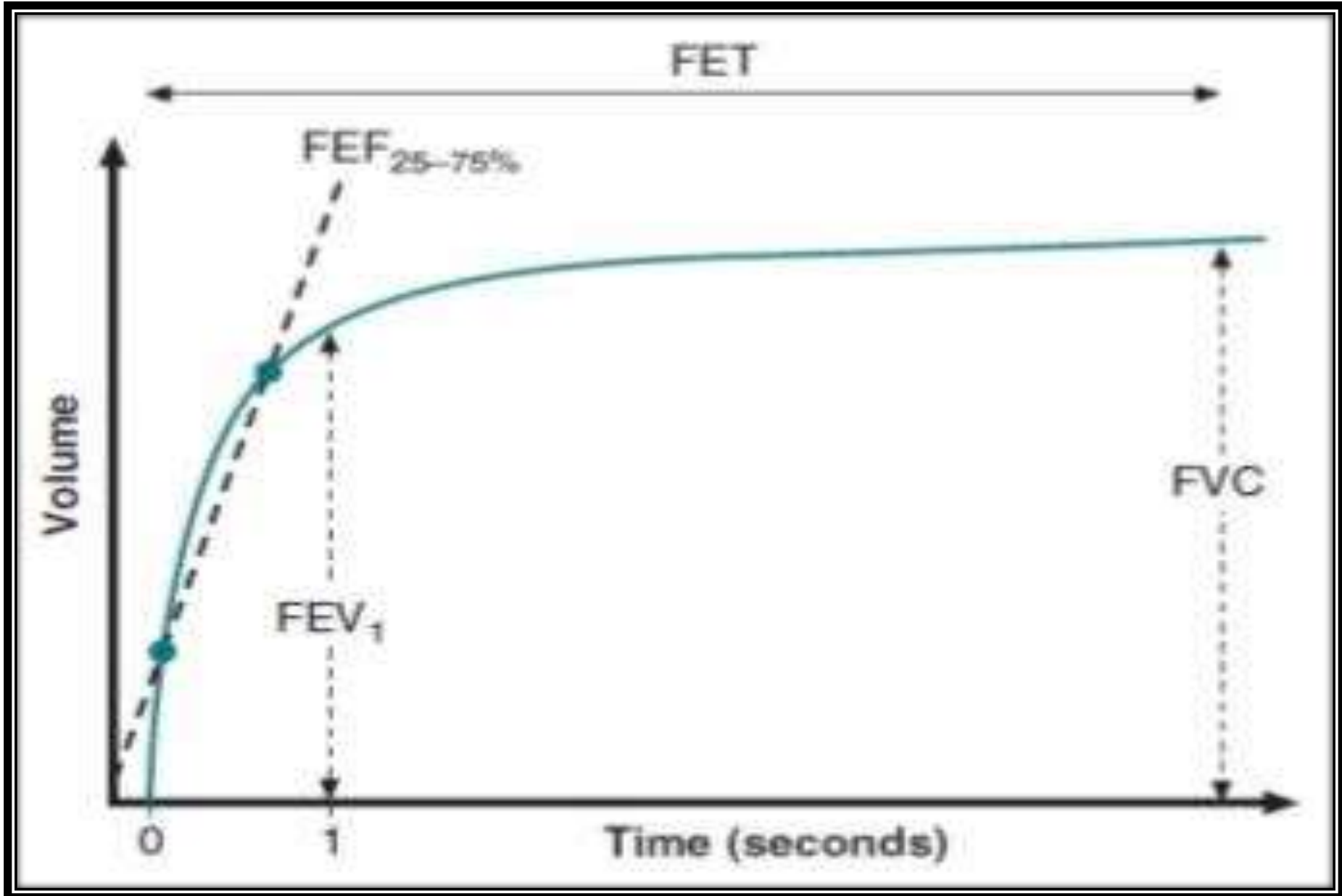

Severe obstructive lung disease *(Flow - Volume Trends)*

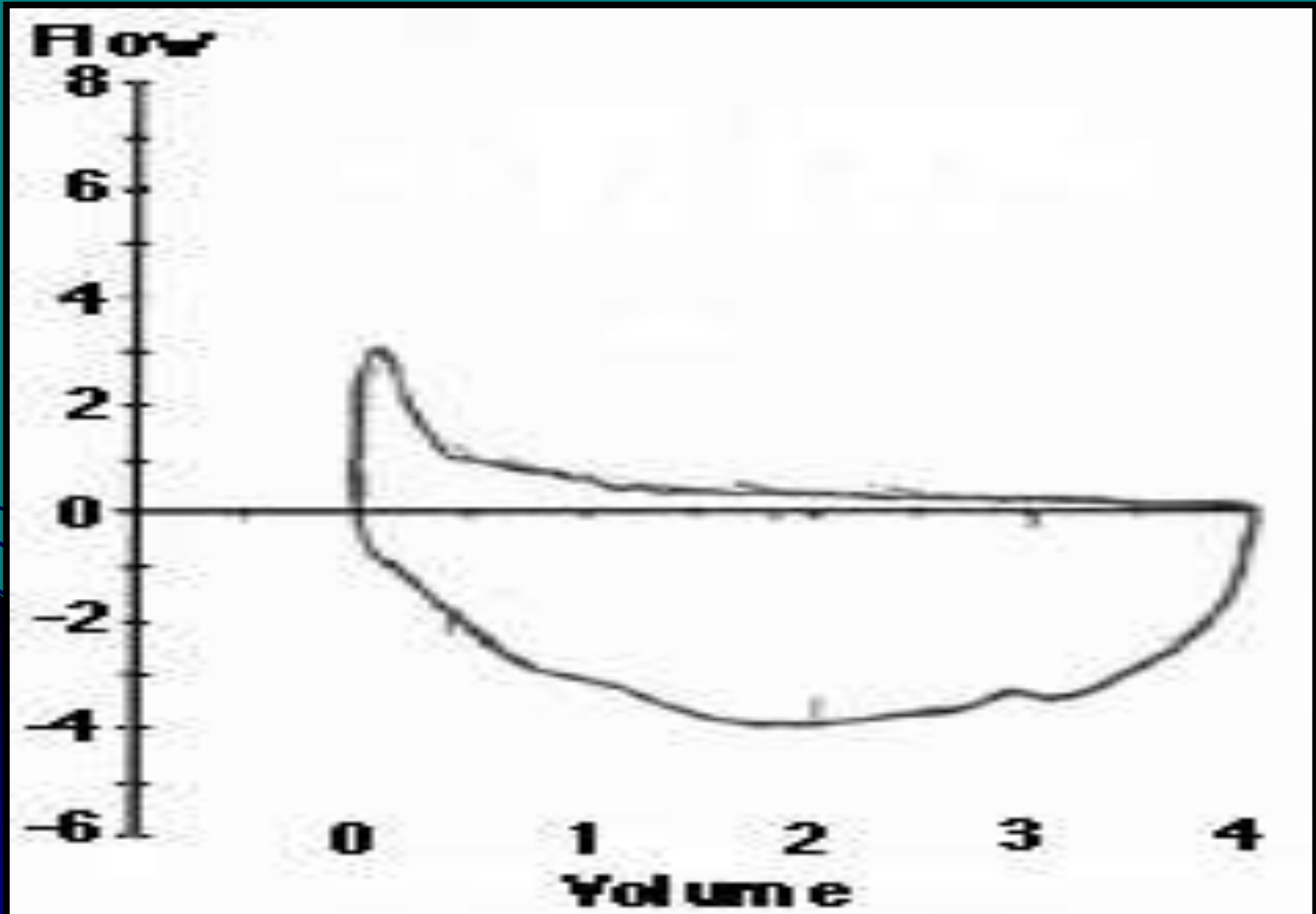

Severe restrictive lung disease (Flow - Volume Loop)

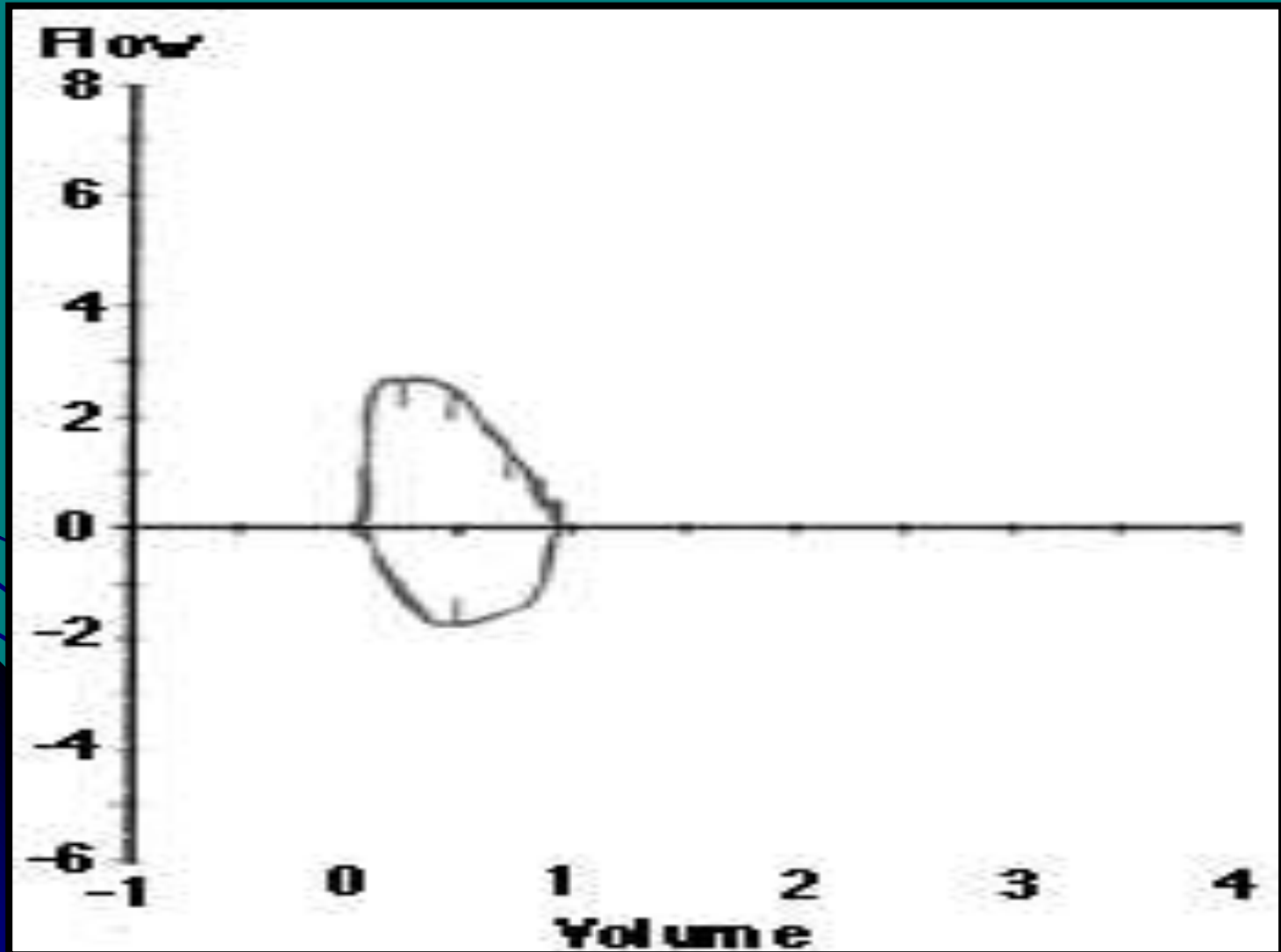

Restriction (Flow - Time Line)

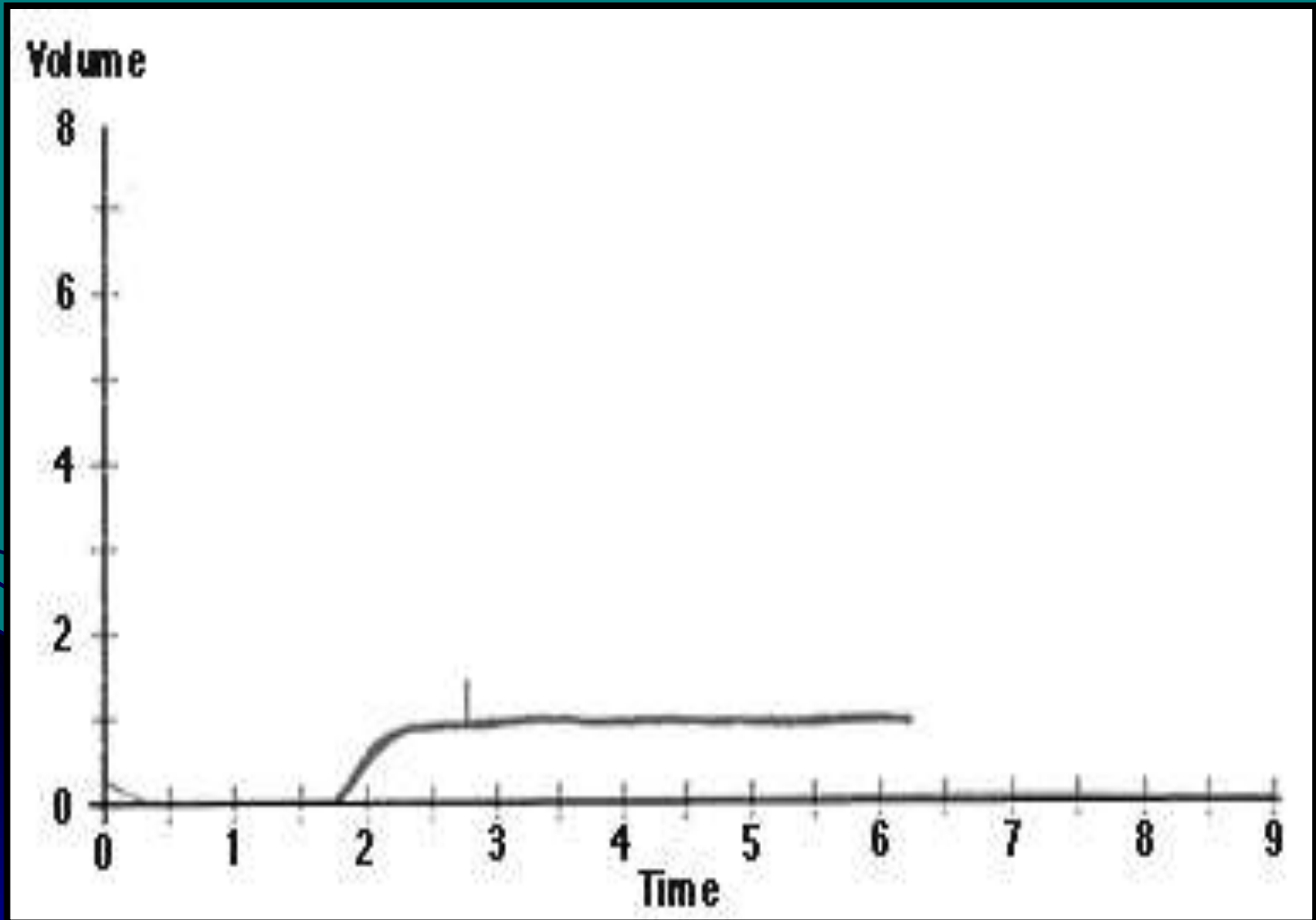

Local aspiration..

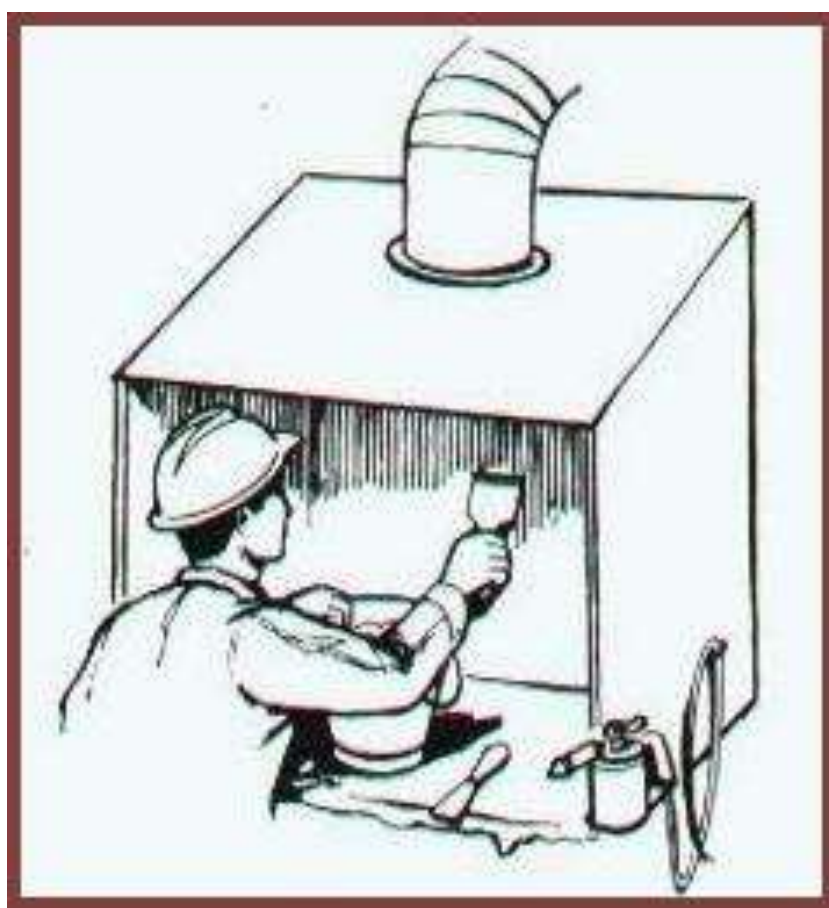

Aspiration at source
Primary prevention



Smoking at worksite is extremely dangerous

Fire; excess inhalation of toxic fumes, explosion

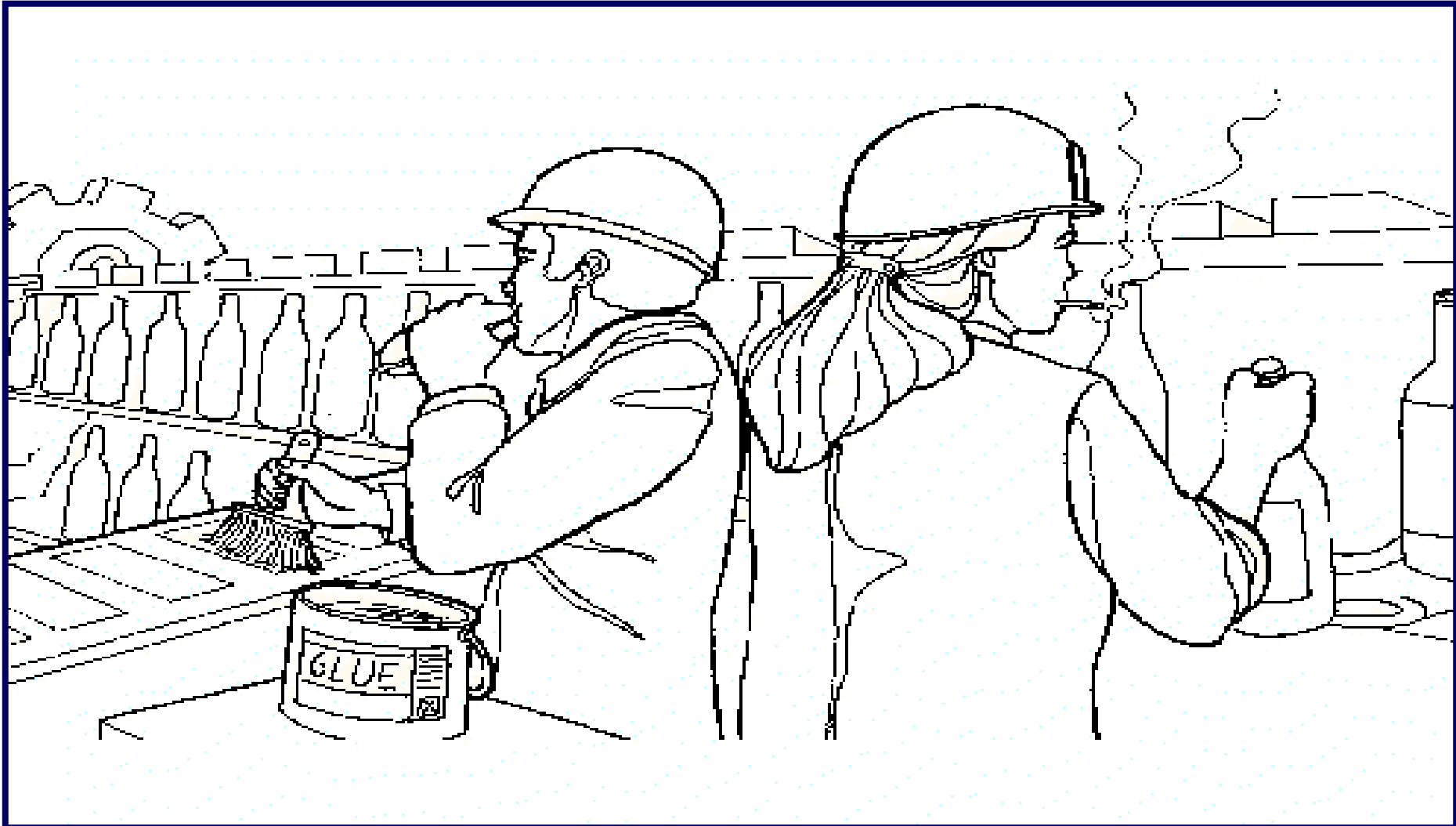

SONOMETER

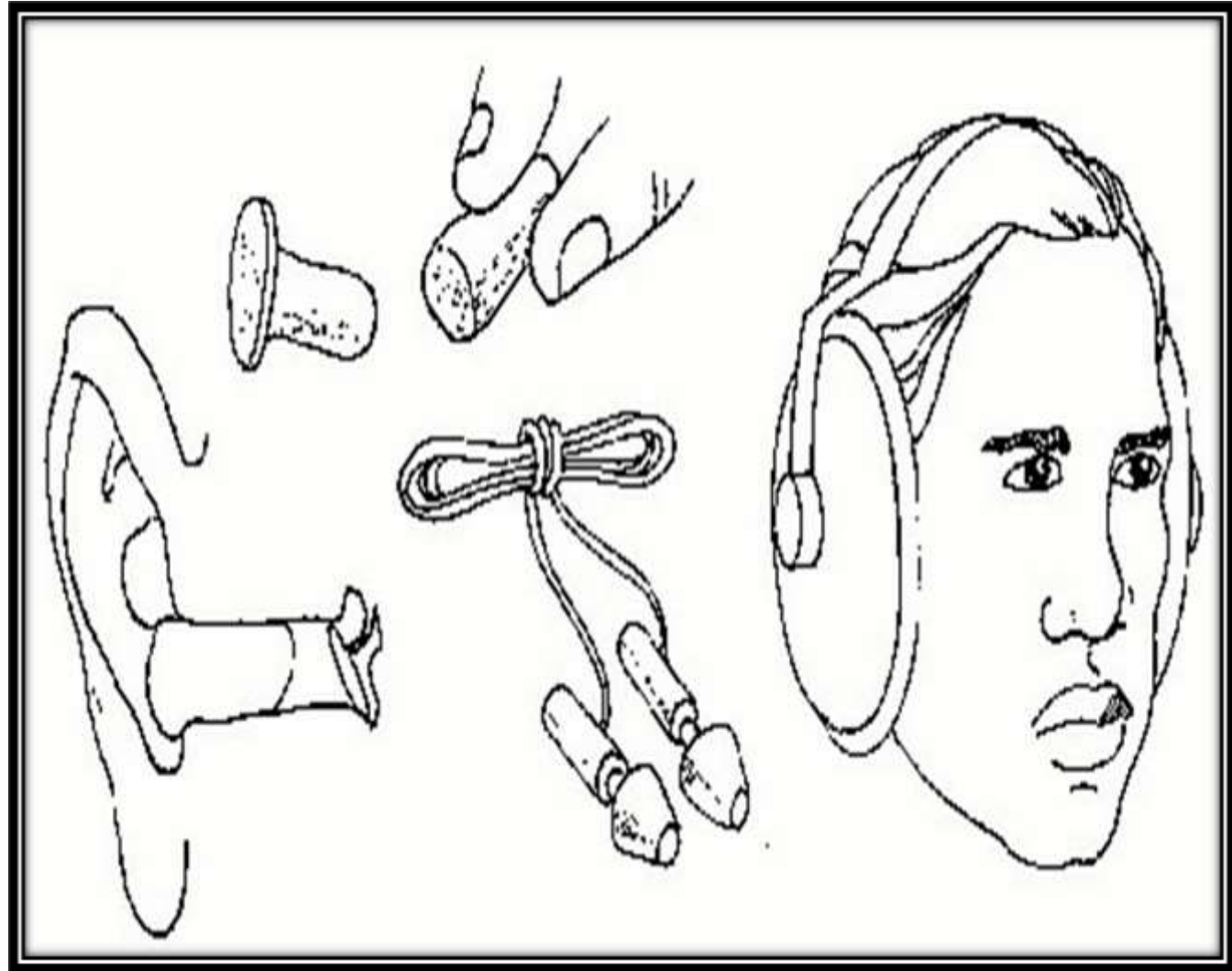
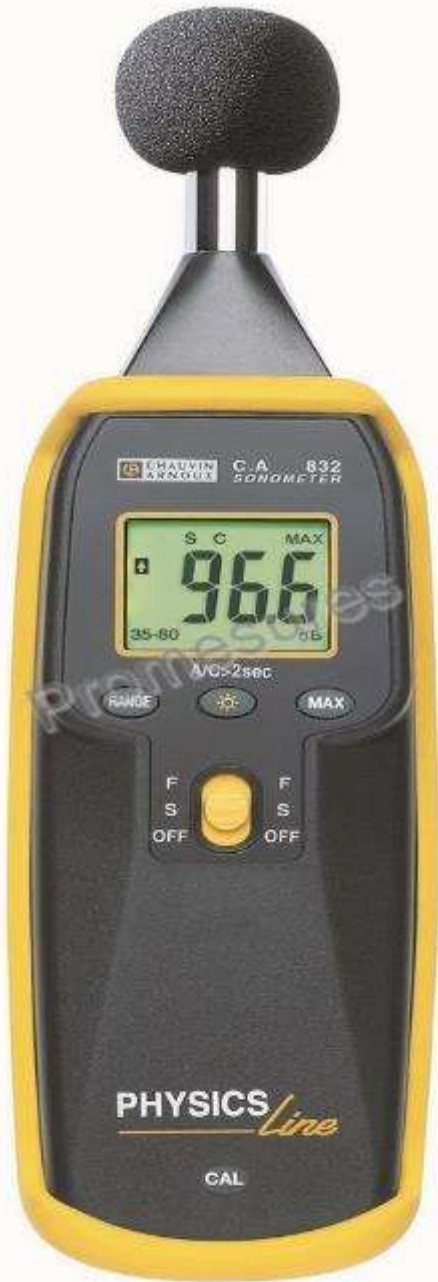

Noise is dangerous!

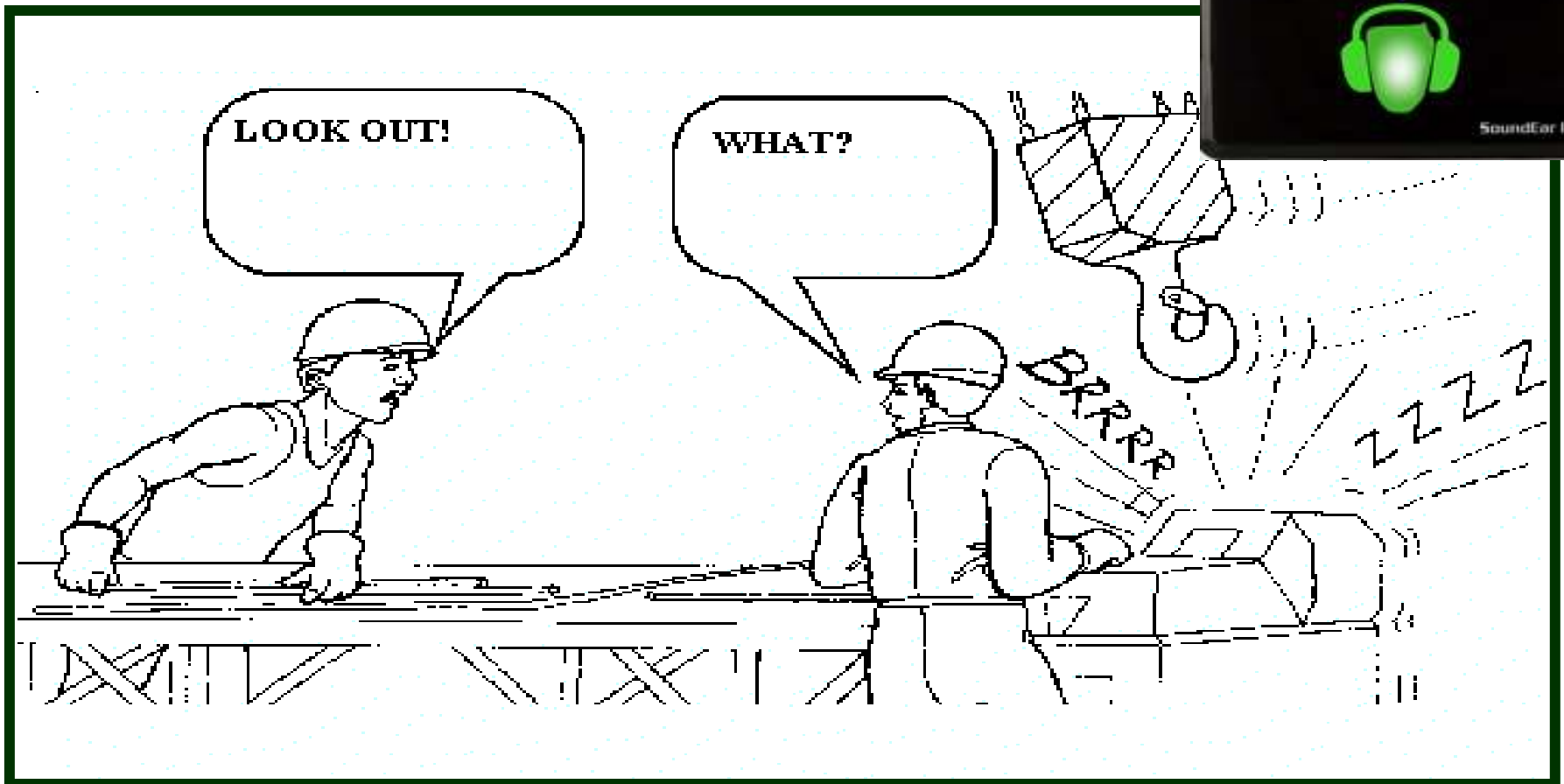

Methods of noise control..

How can noise be controlled?

Workplace noise can be controlled:

- (1) **at the source;**
- (2) through the use of **barriers;** and
- (3) **at the worker.**

(All Primary prevention)

Periodic audiometry :

(Secondary prevention for early diagnosis)

Hearing aid : Tertiary prevention.. (Rehabilitation)

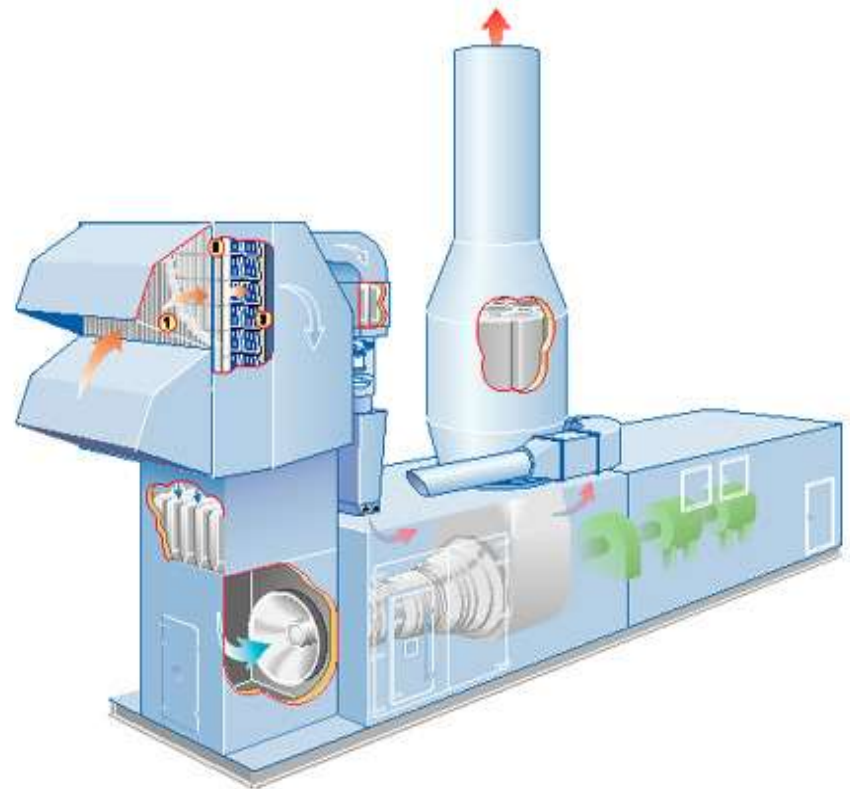

Put a silencer on the machine instead of ear protectors on the workers..

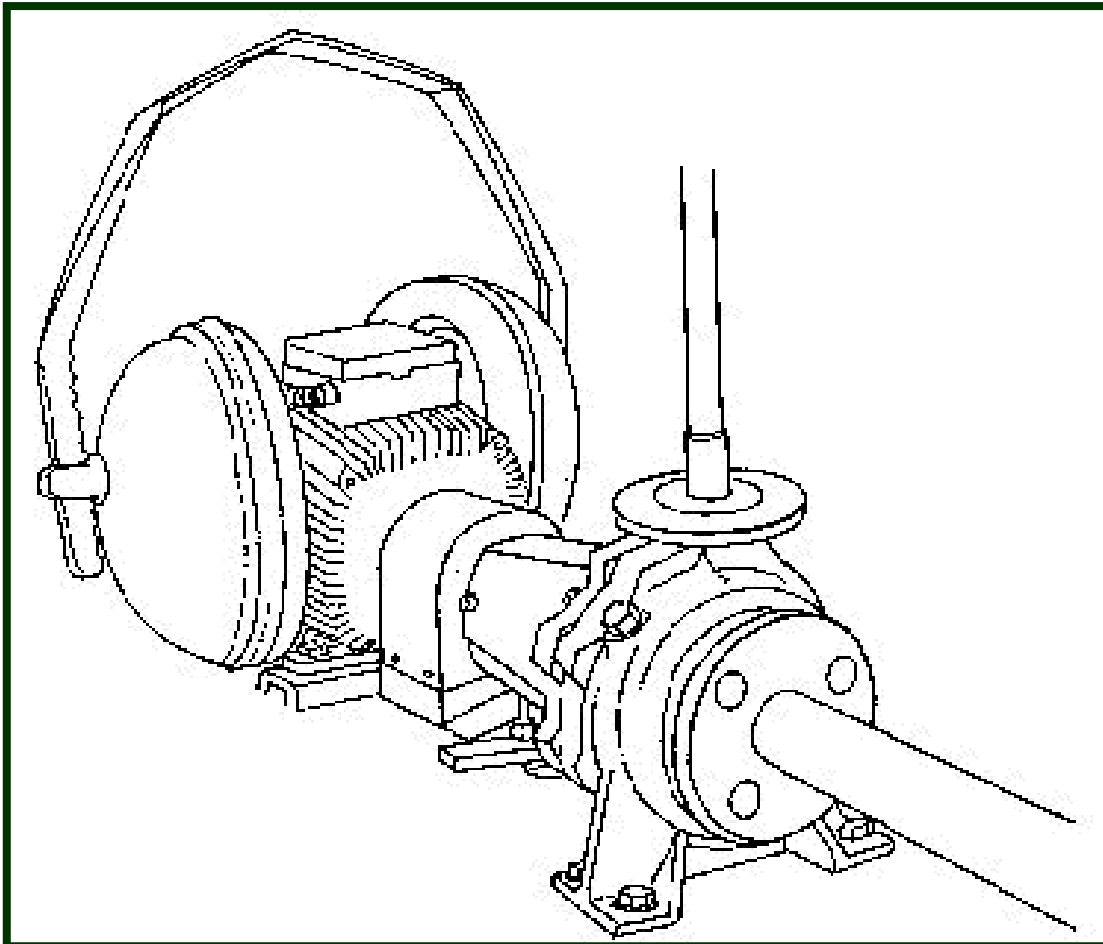



(dBA) Audiometric traces : Deficit at 4-6 KHz

Caution : *Hearing loss due to noise is bilateral and permanent!*

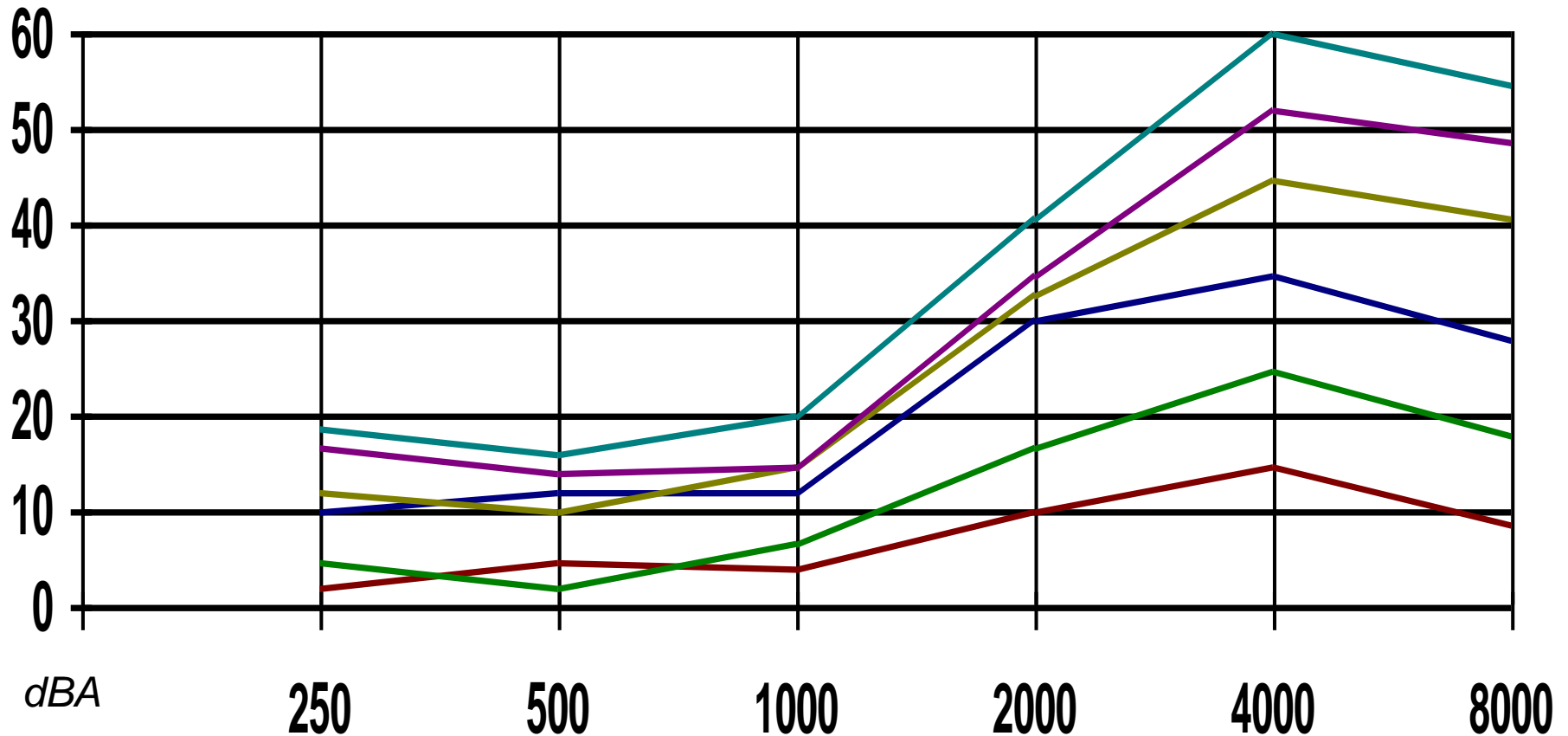

No. of hours exposed

Sound level dB

8

90

6

92

4

95

3

97

2

100

1.5

102

1

105

0.5

110

0.25 or less

115



DIFFICULTY of BEING a BALLET/BALLERINA

Physical risk factors; a typical sample

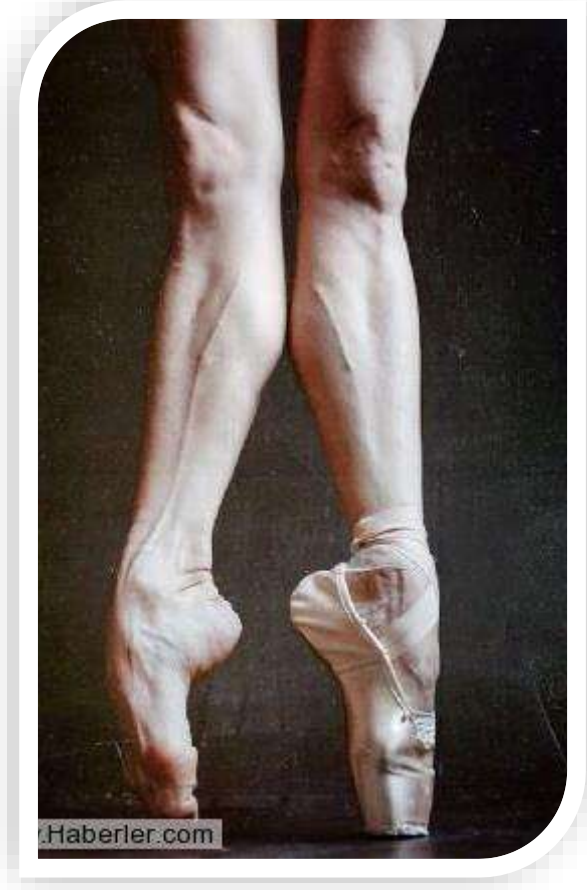

Russian ballerina Darian Volkova



6/6/2021

54

Hierarchy of Control Measures

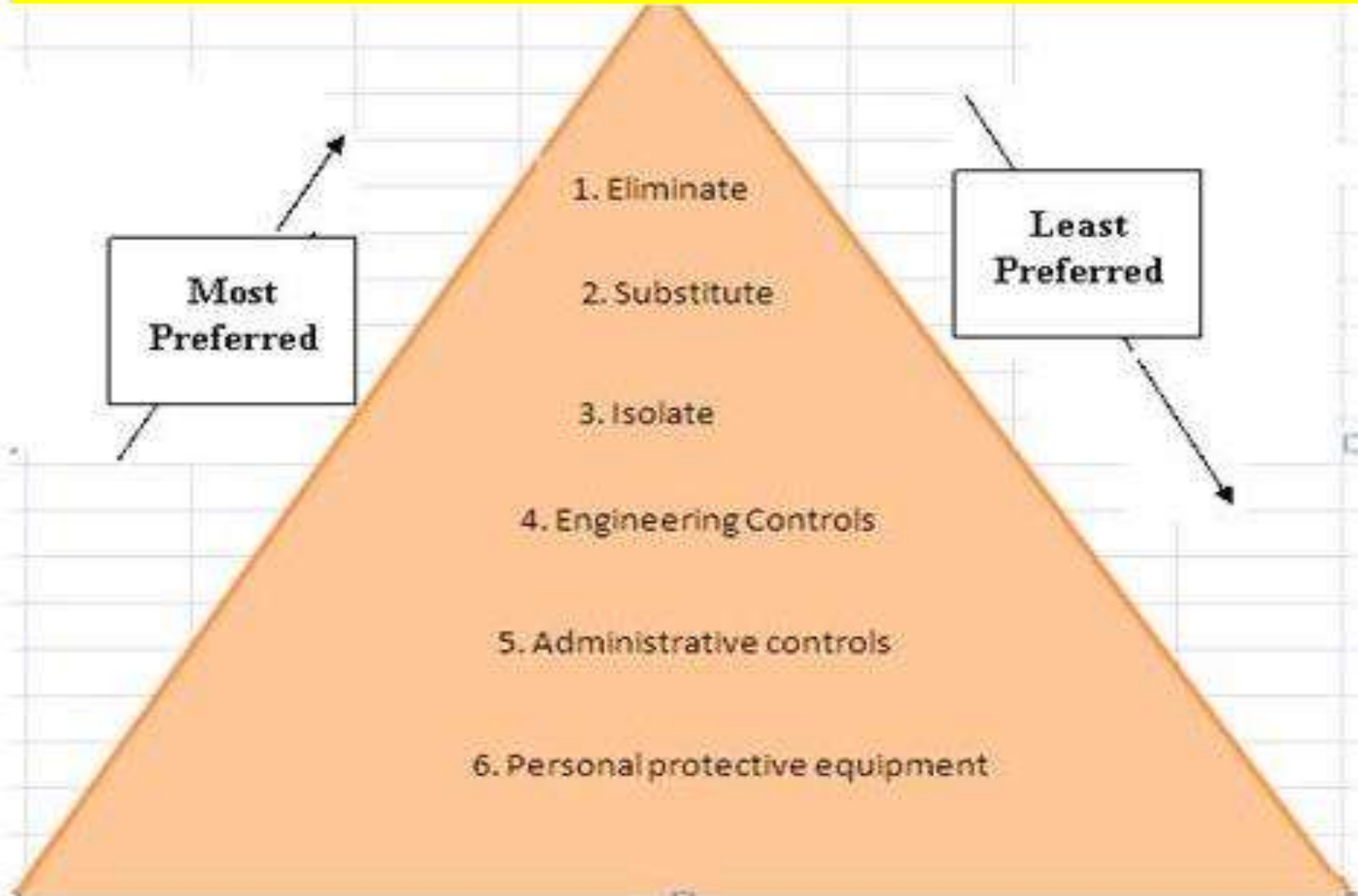

28 April - World Day for Safety and Health at Work

- The theme for the 2015 World Day for Safety and Health at Work is "***Safety and health in the use of chemicals at work***". Chemicals are key to modern life, and will continue to be produced and used in workplaces.
With concerted efforts, governments, employers, and workers and their organizations can achieve the sound management of chemicals for an appropriate balance between the benefits of chemical use and the preventive and control measures of potential adverse impacts on workers, workplaces, communities and the environment.

World Day for Safety and Health at Work

Safety and health at work:

Everyone has a role, know yours

Today, 865 000 people will either die or be injured doing their job. Every year, 2.8 trillion US \$ are taken up by lost working time, treatment, compensation and rehabilitation of occupational injuries and diseases.

Ensuring decent, safe, and healthy working conditions and environments is the responsibility of us all.

Join in building a culture of prevention on Occupational Safety and Health

<http://www.ilo.org/global/lang--en/index.htm>, 18.4.15



World Day for Safety and Health at Work

**Safety and health at work:
Everyone has a role,
know yours**



A national occupational safety and health culture is one in which the right to a safe and healthy working environment is respected at all levels, where governments, employers and workers actively participate in securing a safe and healthy working environment through a system of defined rights, responsibilities and duties, and where the highest priority is accorded to the principle of prevention.

<http://www.ilo.org/safework/events/safeday/lang--en/index.htm>, 18.4.15

World Day for Safety and Health at Work

**Safety and health at work:
Everyone has a role,
know yours**



This year, we have improved the SafeDay web page with new and useful information including the role of each stakeholder, more detailed information on key aspects and trends on OSH, as well as a campaign kit to organize your event which includes the PPT presentation with notes, the poster and the brochure which you can download for your event.

<http://www.ilo.org/safework/events/safeday/lang--en/index.htm>, 18.4.15



World Day for Safety and Health at Work

**Safety and health at work:
Everyone has a role,
know yours**



Please note that the first time you visit the SafeDay interactive web page you have to complete the 'journey' towards building a culture of prevention on OSH. Then you will be able, by clicking on the menu (the red button at the top left), to go back to any relevant information directly such as, training tools, etc. The time for uploading the interactive web page depends on the internet connection and the browser you use. <http://www.ilo.org/safework/events/safeday/lang--en/index.htm>, 18.4.15

World Day for Safety and Health at Work

**Safety and health at work:
Everyone has a role, know yours**

Partners



International Organisation of Employers (IOE)

International Trade Union Confederation (ITUC)

World Health Organization (WHO)

International Social Security Association (ISSA)

Korea Occupational Safety and Health Agency (KOSHA)

National Research and Safety Institute for the Prevention of Occupational Accidents and Diseases (INRS) in France

Workplace Safety and Health Institute and Workplace Safety and Health Council in Singapore

<http://www.ilo.org/safework/events/safeday/lang--en/index.htm>, 18.4.15

Every 15 seconds, a worker dies from a work-related accident or disease

Every 15 seconds, 153 workers have a work-related accident.

Every day, 6,300 people die as a result of occupational accidents or work-related diseases – more than 2.3 million deaths per year. **317 million accidents occur on the job annually**; many of these resulting in extended absences from work. The human cost of this daily adversity is vast and the economic burden of poor **occupational safety and health** practices is estimated at 4 % of global Gross Domestic Product each year.

<http://www.ilo.org/global/topics/safety-and-health-at-work/lang--de/index.htm>, 14.2.17

World Day for Safety and Health at Work

Safety and health at work:

Everyone has a role, know yours

Safe Day History



Since 2003, the ILO observes the World Day on Safety and Health at Work on April 28 capitalizing on its traditional strengths of ***Tripartism and Social Dialogue.***



***A carpenter's
hands with
amputated
fingers..
due to
worksite
accidents ..***

ILO SafeDay History

http://www.ilo.org/moscow/areas-of-work/occupational-safety-and-health/WCMS_305902/lang--en/index.htm, 02.03.2017

2017 – **Optimize the collection and use of OSH data**

2016 – **Workplace Stress: A collective challenge**

2015 – **Join in building an OSH preventive culture**

2014 – **Safety and health in the use of chemicals at work**

2013 – **Prevention of occupational diseases**

2012 – **Promoting safety and health in a green economy**

2011 – **Occupational Safety and Health Management System:
A tool for continual improvement**

2010 – **Emerging risks and new patterns of prevention in a changing world of work**

2009 – **Health and life at work: A basic human right**

2008 – **My life, my work, my safe work: Managing risk in the work environment**

2007 – **Safe and healthy workplaces: Making Decent Work a reality**

2006 – **Decent Work: Safe Work: HIV/AIDS**

2005 – **Creating and sustaining a preventative safety and health culture**

2004 – **Creating and sustaining a safety culture**

2003 – **Safety and health culture in a globalized world**



International
Labour
Office

World Day for Safety and Health at Work

Safety and health at work: Everyone has a role, know yours!

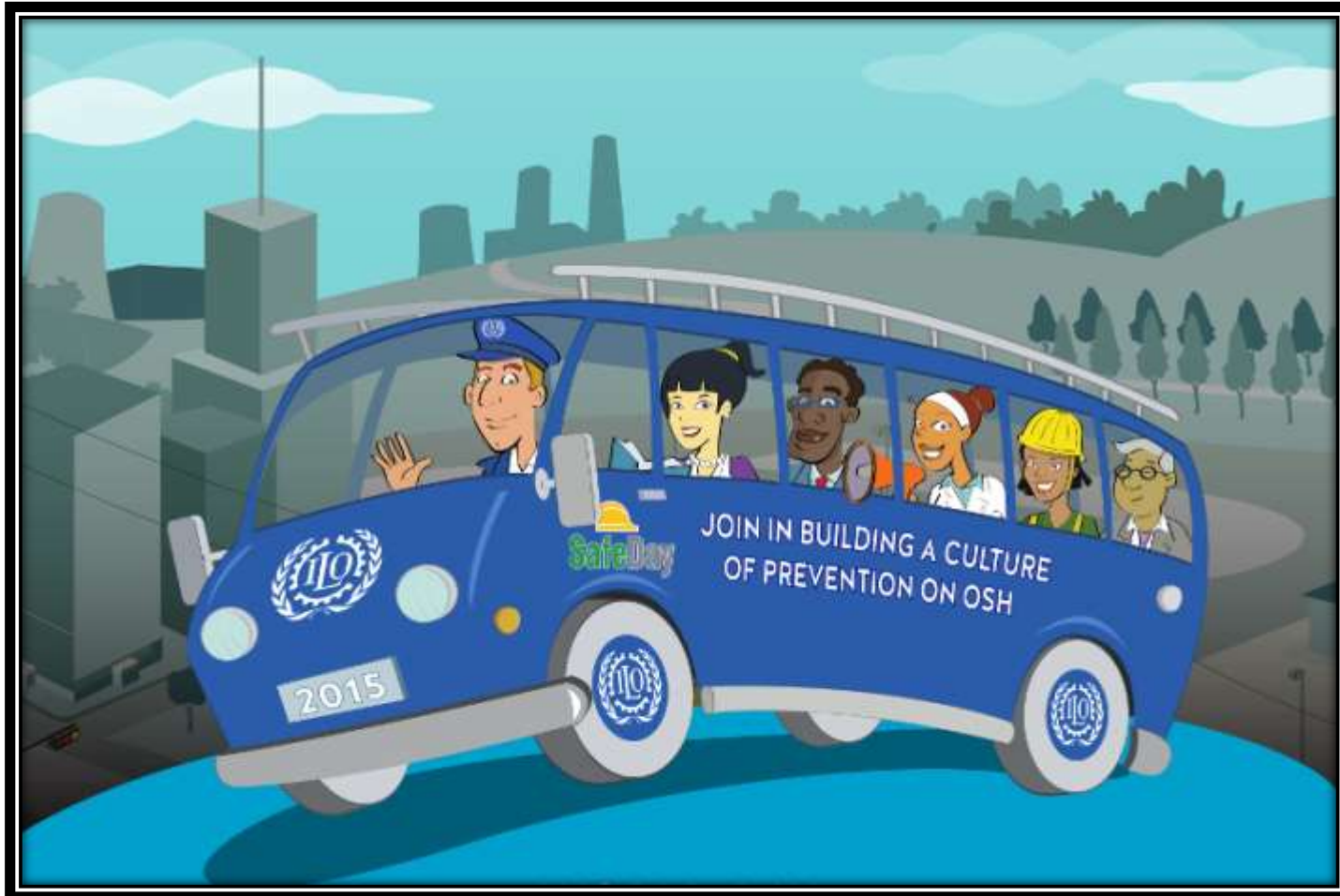

safeday@ilo.org



WORLD DAY FOR SAFETY AND HEALTH AT WORK - 28 APRIL 2015 JOIN IN BUILDING A CULTURE OF PREVENTION ON OSH



<http://www.ilo.org/legacy/english/osh/index.html#>, 18.4.15

□ World Day for Safety and Health at Work – 28 Nisan 2016

'Workplace stress' :

It's time to lift the burden'

The ILO is committed to work with governments, workers and employers and their organizations around the globe to design and implement effective national, regional and enterprise level policies to prevent and minimize work-related stress.

http://www.ilo.org/global/about-the-ilo/how-the-ilo-works/ilo-director-general/statements-and-speeches/WCMS_475093/lang--en/index.htm





International
Labour
Organization

SAFE DAY HISTORY

Since 2003, the ILO observes the World Day on **Safety and Health** at Work on April 28 capitalizing on its traditional strengths of *tripartism and social dialogue*.

This year, 28th April 2016;

“Workplace Stress: a collective challenge”

is the theme of the campaign of the World Day for Safety and Health at Work. The report will draw attention to current global trends on work-related stress and its impact.



<https://www.napofilm.net/en/napos-films/napo-when-stress-strikes>, Please watch this video..



SafeDay

"Accurate data will help to save lives."

ILO Director-General on 2017 World Day for Safety and Health at Work.

The ILO welcomes the opportunity to work with member States, social partners and other interested parties to face this **OSH data challenge** and meet their commitment on the implementation of the objectives of the **2030 Sustainable Development Agenda** and their obligations under ILO conventions.

WHO : *The number of people living with depression increased by more than 18% between 2005 and 2015.*

- **Depression: Let's talk**
- World Health Day, celebrated on **7 April** every year to mark the anniversary of the founding of WHO, provides us with a unique opportunity to mobilize action around a specific health topic of concern to people all over the world.
- The theme of 2017 World Health Day campaign is **depression**.



28 April - World Day for Safety and Health at Work

- The theme for the 2015 World Day for Safety and Health at Work is ***“Safety and health in the use of chemicals at work”***.
- Chemicals are key to modern life and will continue to be produced and used in workplaces. With concerted efforts, governments, employers, and workers and their organizations can achieve the sound management of chemicals for an appropriate balance between the benefits of chemical use and the preventive and control ***measures of potential adverse impacts on workers, workplaces, communities and the environment.***

Chemical safety data sheets are published under several names, such as:

International chemical safety card,

ICSC Chemical safety card

Chemical info-sheet

Material safety data sheet, MSDS

Product safety data sheet

Health and safety data

Safety data sheet.



How to change irrational behaviours?(1)

- Policymakers must be responsible with when and how they use available interventions to affect **health behaviours**.
- Policymakers must look for constraints, externalities,* or *behavioural biases* to justify intervention.
- Fortunately, some individuals with *behavioural biases* may explicitly ask for interventions.

* **Externalities** are indirect effects on other agents that an individual does not fully consider when making his/her decisions.

(Oxford Textbook of Public Health, pp. 775-789)



A pernicious, irrational choice of behaviour.

How to change irrational behaviours?(2)

- They may recognize that they need help to engage in certain desirable behaviours like going to the gym, eating healthily, or taking their medications.
- In these cases, individuals will happily sign up for studies designed to test ways to *impact behaviour*, allowing us to conduct more research.
- In addition, they will happily opt (*choose*) in to programmes policymakers design to effectively encourage ***behaviour change***.
(Oxford Textbook of Public Health, pp. 775-789)



How could we change these type of irrational behaviours?



'Least developed countries' pose the next big globalisation challenge..



78

<http://www.theguardian.com/global-development/poverty-matters/2011/mar/30/least-developed-countries-globalisation-challenge>



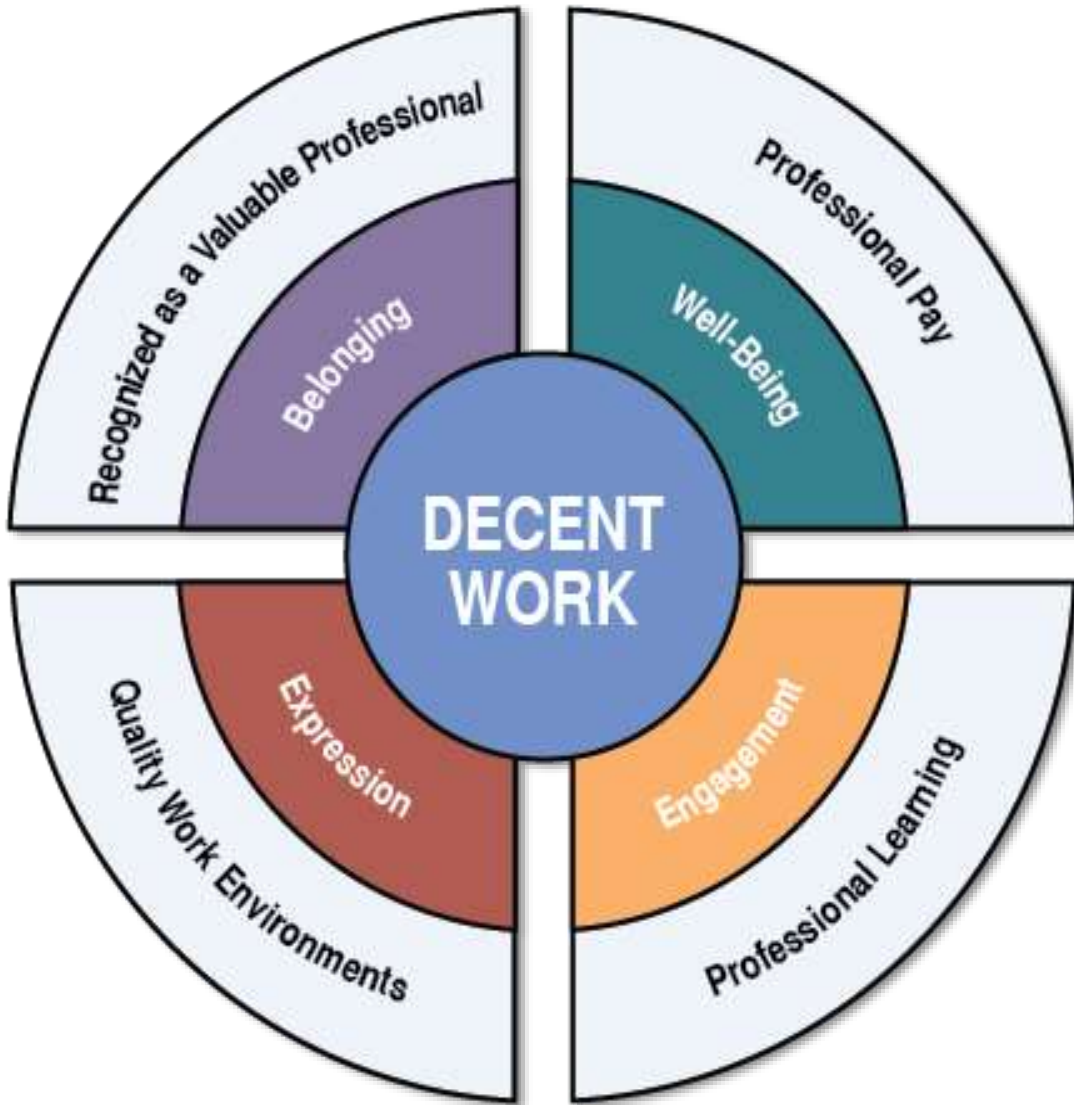

8 DECENT WORK AND ECONOMIC GROWTH

WHAT IS "DECENT WORK"?

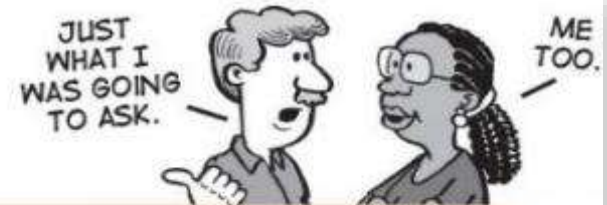

DECENT WORK IS WORK THAT...

- ➔ is meaningful and productive
- ➔ pays a living wage
- ➔ provides benefits and social protections
- ➔ is protected by strong labour laws that guarantee workers' rights, including freedom of association (the right to join and be represented by a union)



Decent work benefits both individuals AND communities. It helps maintain family stability, creates peace in communities, promotes healthy democratic participation, and leads to more equitable and productive economic growth.



SUSTAINABLE DEVELOPMENT GOALS

2030

DECENT WORK AND THE 2030 AGENDA

THEY FACE SIGNIFICANT ECONOMIC INSECURITY.

74%

Live on less than \$13 per day

45%

Work in low-skill or manual occupations

77%

Work in part-time, temporary, "vulnerable," or unpaid jobs

THEY ARE GROWING OLDER AND LESS HEALTHY.

18%

Of labor force over 55 by 2030

52%

Of adults overweight or obese

9%

Of adults with diabetes

76%

Are "struggling" or "suffering" in their physical wellbeing

THEY ARE STRESSED, UNHAPPY, AND EVEN UNSAFE AT WORK.

38%

Suffer from excessive pressure on the job

24%

Are actively disengaged at work

2.3M

Annual work-related deaths

313M

Annual work-related accidents

Figure 4.1. The economic cycle of disease

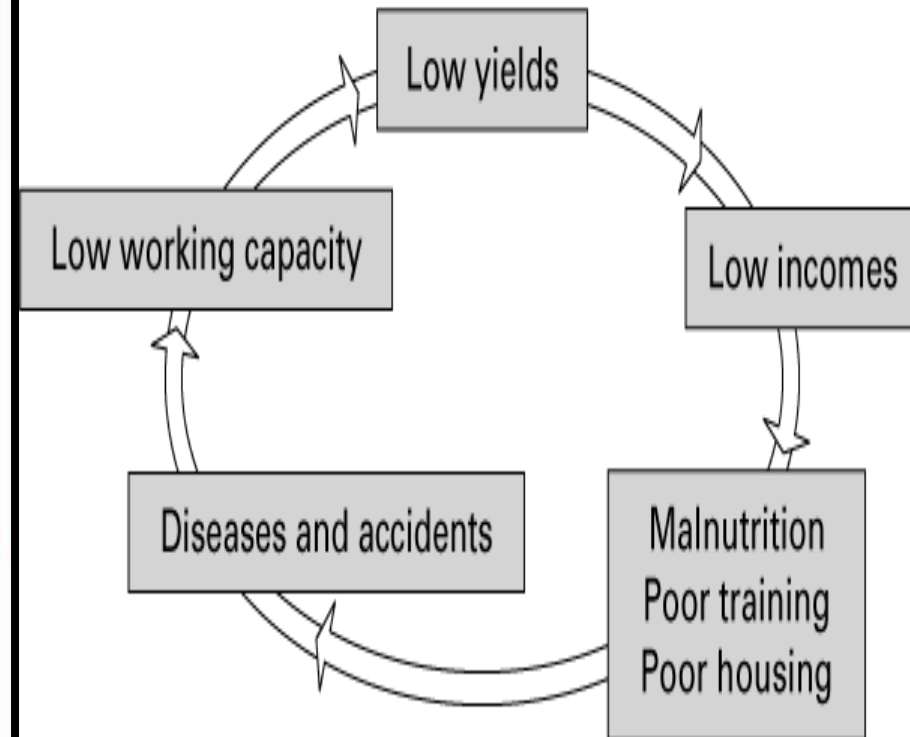

Source: "Teaching ergonomics and occupational safety and health in tropical agriculture and forestry" (National Board of Occupational Safety and Health, Stockholm, 1982).

Global Burden of Disease from Occupational Diseases and Injuries

- 25% of the global burden of disease and mortality is due to occupational and environmental risk factors¹
- 2 million deaths per year globally are attributable to occupational diseases and injuries²
- 90,000 die annually from asbestos-related diseases³

Global burden of disease: occupational risk factors

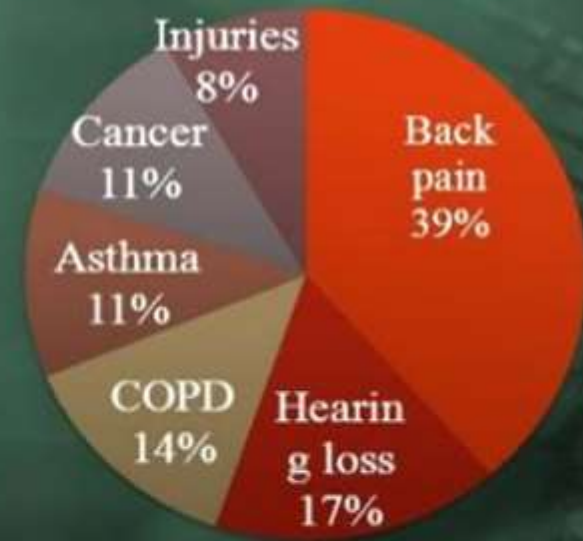

Pan American
Health
Organization

Source: Rosenstock, Cullen, Fingerhut, 2006

1. Pruss-Ustun & Corvalan 2006; 2. ILO/WHO 2005; 3. WHO 2006



The Death Game in illegal quarries



General Maden-İş Union President Yeşil made striking allegations regarding the "*illegal quarries*" in which two people lost their lives. Yeşil said, "Those who die in illegal quarries are left directly at the bottom of the poles, in front of the hospital, as if they died elsewhere." said. (**Cumhuriyet**, 03.02.2020)

Walking towards the unknown..



✓ *All workers have the right to safe and healthy working conditions.*

European Social Charter (Revised), art. 3 (<https://rm.coe.int/168007cf93>) 06.06.2021

<https://youtu.be/vdNt9wMfPL8?list=PLy62ZXxDue49zjh1l8esX-QBJb4noBDxF>



Thank You

